

HIGHLANDER
LGV95/HL152 AH



OFF ROAD SEATING MANUFACTURER



HIGHLANDER











UnitedSeats presents a new high back AIR seat the LGV95/HL152 AH (Highlander) for construction and industrial machines. It features integrated controls and powered adjustment for weight and height settings. Its cushions provide optimal comfort levels for operators and a wide range of adjustments to enhance cab ergonomics. The horizontal suspension reduces the buffeting motion of front to rear shocks.

It has a large variety of external mounting holes to facilitate installations for both OEM's and aftermarket users.





STANDARD FEATURES

- | | | |
|---|--|--|
|  Pneumatic suspension
24V integrated compressor
120 mm suspension stroke |  Horizontal suspension |  Slide rail travel
210 mm |
|  Height adjustment
80 mm |  Backrest adjustment |  Adjustable armrests |
|  Weight adjustment
50 - 135 kg |  Mechanical lumbar support |  Headrest |
|  Document box |  Adjustable damper | |

OPTIONAL FEATURES

 **Seat belts**



Seat meets E5 & E11 - ISO 6683 & IWG 78/764



The dimensions on the technical drawing are shown as millimeters (mm)

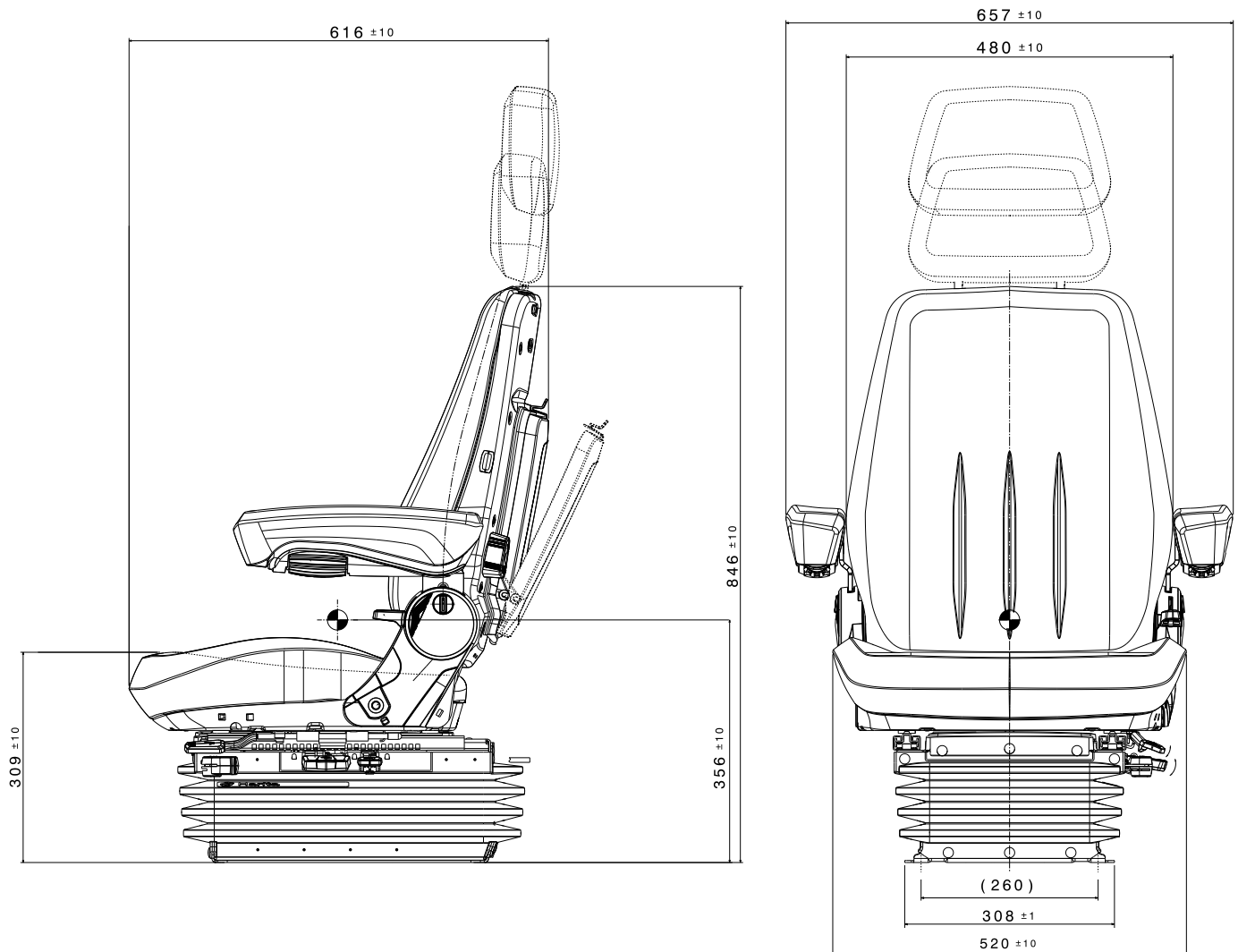



YOUR OFF ROAD **SEATING** MANUFACTURER

Your UnitedSeats dealer:

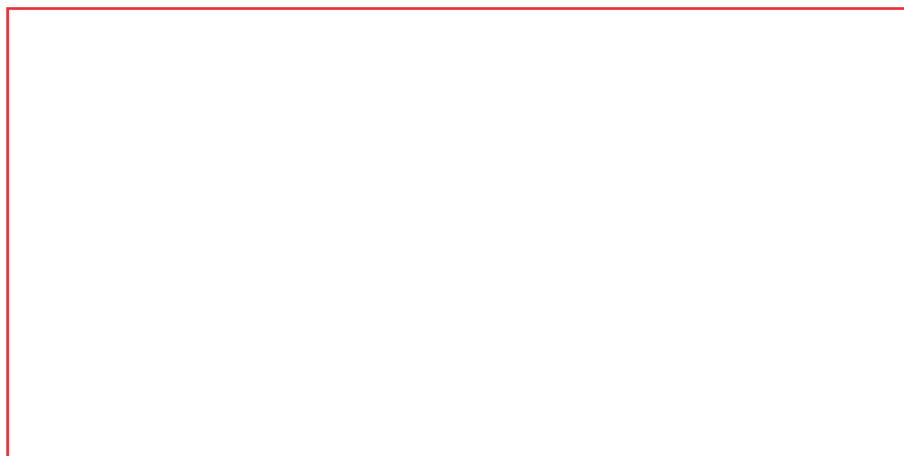

At UnitedSeats we are dedicated to providing a quality service from the initial quotation to final product delivery. Our commitment to service, knowledge and product availability has made us the preferred source for your seating needs.

WWW.UNITEDSEATS.COM

