

RETRO BROWN

CS85/C1 AR



OFF ROAD SEATING MANUFACTURER



CS85/C1 AR (RETRO BROWN)









During the 1980's & 1990's several tractor brands such as John Deere, Case-IH, and David Brown had brown trim interiors, with brown trimmed seats.

To enable farmers to restore their cabins in brown livery, UnitedSeats has introduced the high selling CS85/C1 AR in Retro Brown fabric. This not only provides a comfortable and safe ride but meets aesthetic requirements in those classic tractors





STANDARD FEATURES

-  **Mechanical suspension**
90 mm suspension stroke
-  **Height adjustment**
60 mm in 3 stages
-  **Weight adjustment**
50 - 125 kg
-  **Slide rail travel**
150 mm
-  **Backrest extension**
-  **Armrests**
-  **Backrest adjustment**
-  **Mechanical lumbar support**

OPTIONAL FEATURES

-  **Seat belt**
-  **Heaters with 12v, 24v or 48v elements**
-  **Operator presence switch**
-  **Turntable**

Optional

AVAILABLE SUSPENSIONS



Seat meets E5 + E11 - ISO 6683 & IWG 78/764



C1 AR seat upper also available

The dimensions on the technical drawing are shown as millimeters (mm)

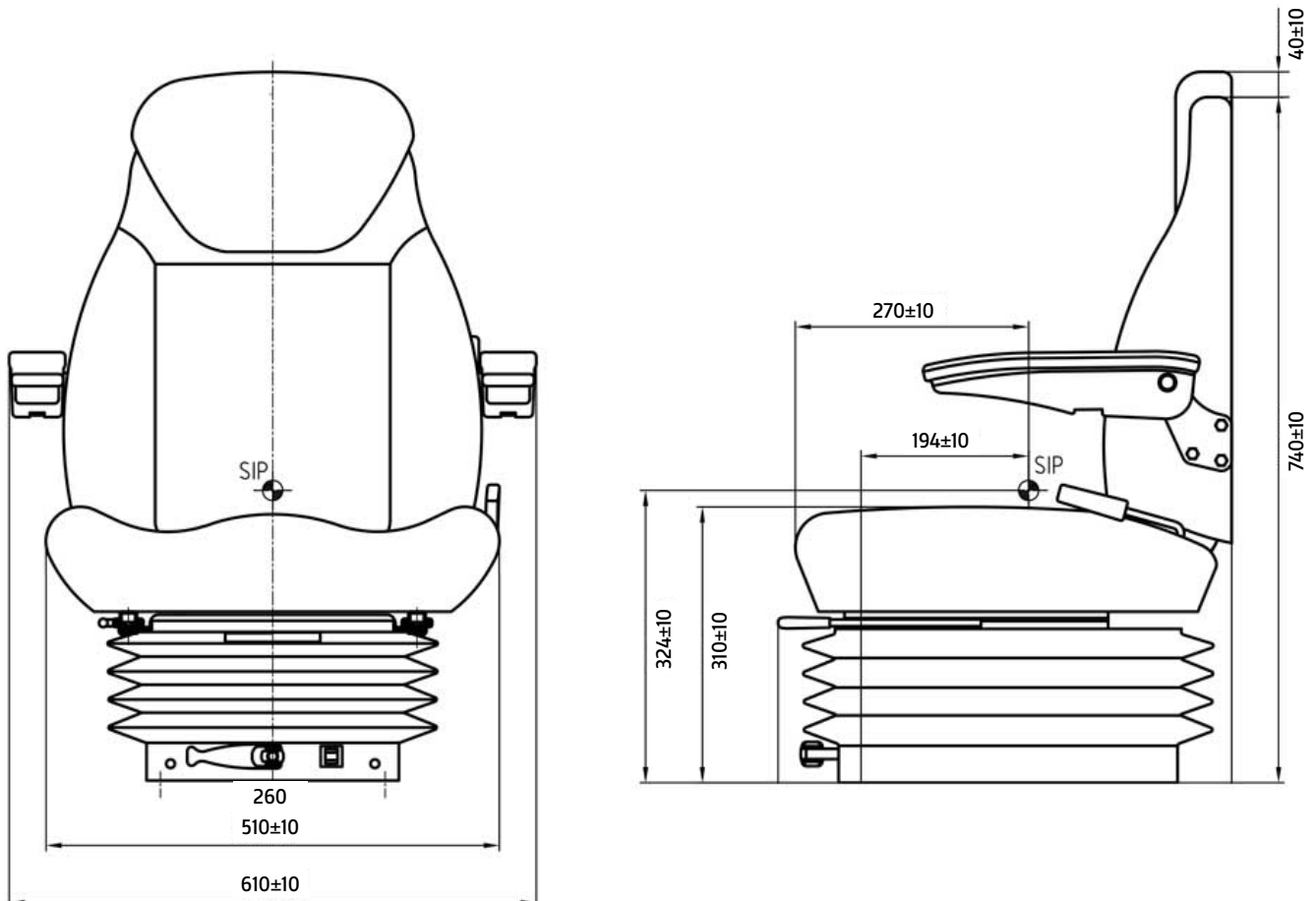



YOUR OFF ROAD **SEATING** MANUFACTURER

Your UnitedSeats dealer:

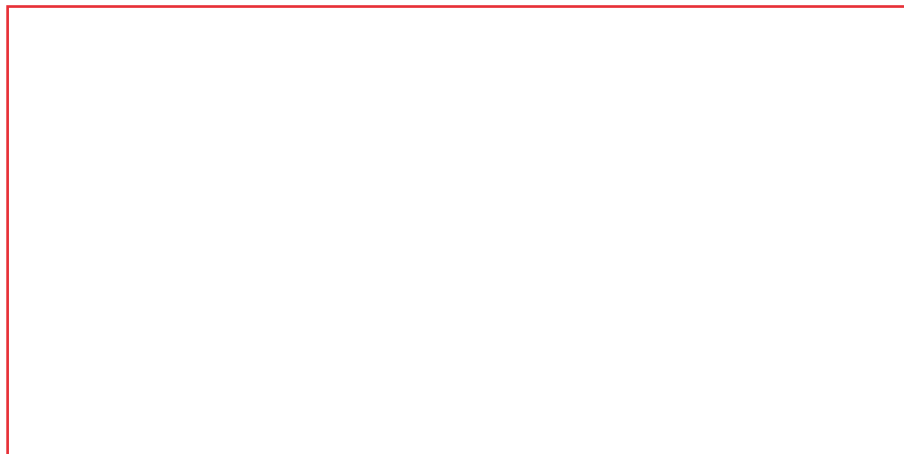

At UnitedSeats we are dedicated to providing a quality service from the initial quotation to final product delivery. Our commitment to service, knowledge and product availability has made us the preferred source for your seating needs.

WWW.UNITEDSEATS.COM

