



# RANCHER ELITE LUXURY SEAT



OFF ROAD SEATING MANUFACTURER

# RANCHER ELITE

In addition to our comfortable, air-suspended UnitedSeats Rancher Pro seat, our latest and newest version is now available: the UnitedSeats Rancher Elite. The UnitedSeats Rancher Elite is an air suspended agricultural seat and suitable for large/medium sized tractors. The seat is also suitable for construction machinery and various earthmoving machines. This new version of the UnitedSeats Rancher Pro has a new seat upholstery with a luxurious look and feel. The Rancher Elite has a turntable of 180 degrees which makes it easy and simple to get out of the seat of a vehicle.

Additional features of this Rancher Elite are the DDS and APS system. The DDS system is a smart damping system, which calculates and installs the right damping that needs to be set to properly absorb vibrations and shocks. The APS (Automatic Positioning System) provides automatic driver weight adjustment, especially useful when several drivers use the same seat. Both systems contribute to create the optimal seating comfort.

Last, but not least, is the KLIMA system of this seat: 3 settings for cooling and heating of the seat. With the Rancher Elite you can continue working during hot or cold working conditions by adjusting the temperature of the seat.

Fully adjustable comfortable armrests

Comfortable seat cushion 520 mm width

Seat depth and tilt adjustment

Pneumatic heavy duty suspension 12V compressor

Horizontal suspension

Adjustable backrest extension

Document box

KLIMA system: cooling and heating

Comfort foam cushion with pneumatic lumbar support

Easy to operate fully adjustable backrest

Turntable 180°







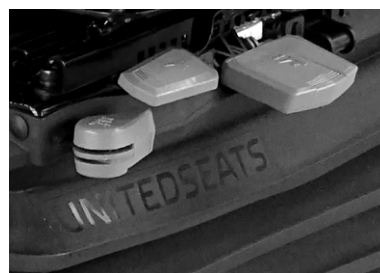











Powered height/weight adjustment

Slide rail adjustment



Wide variety of mounting holes at 260 mm centres



## STANDARD FEATURES

 <b>Pneumatic suspension</b> 12V integrated compressor 120 mm suspension travel	 <b>Horizontal suspension</b>	 <b>Slide rail travel</b> 210 mm	 <b>Seat cushion depth &amp; tilt adjustment</b>
 <b>Height adjustment</b> 80 mm	 <b>Backrest adjustment</b>	 <b>Adjustable armrests</b>	 <b>Fore/aft isolator</b>
 <b>Weight adjustment</b> 50 - 135 kg	 <b>Pneumatic lumbar support</b>	 <b>Backrest extension</b>	 <b>Armrests</b>
 <b>Document box</b>	 <b>KLIMA system: cooling and heating</b>	 <b>Turntable 180°</b>	 <b>Headrest</b>
 <b>Automatic Position System</b>	 <b>Dynamic Damping System</b>		

## OPTIONAL FEATURES

 <b>Seat belt</b>	 <b>Operator presence switch NO/NC</b>
--	---

## TECHNICAL DRAWING

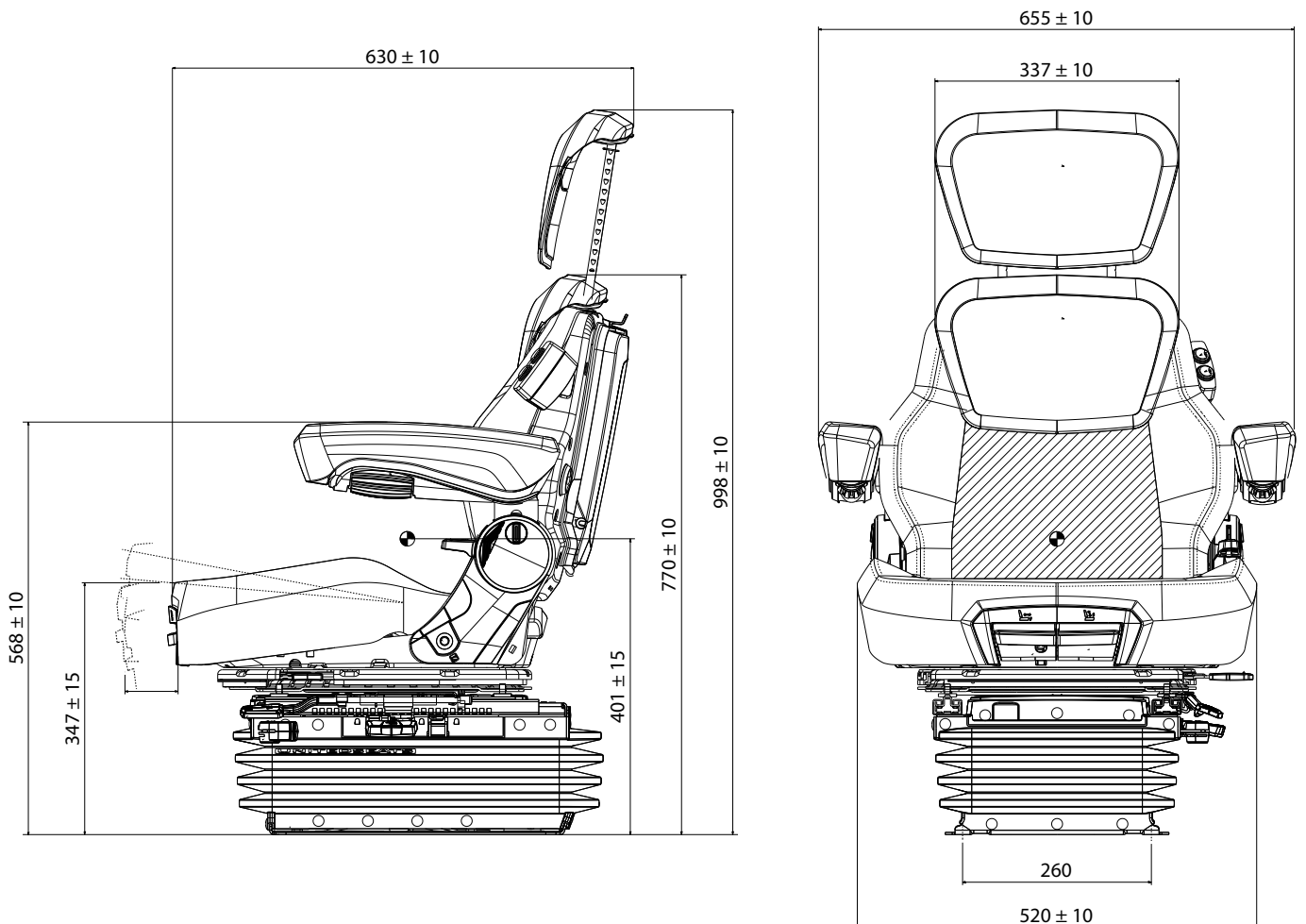



# OFF ROAD **SEATING** MANUFACTURER

# Custom **made in** Holland



At UnitedSeats we are dedicated to providing a quality service from the initial quotation to final product delivery. Our commitment to service, knowledge and product availability has made us the preferred source for your seating needs.

[WWW.UNITEDSEATS.COM](http://WWW.UNITEDSEATS.COM)

