



FORKLIFT SEATING



QUALITY SEATING MANUFACTURER



UnitedSeats for forklift trucks and industrial machines

“We unite your seat”



UnitedSeats is a worldwide manufacturer of off road seating solutions for the industrial, agricultural, construction, transport and marine sectors. All seats are produced under contract for us in a state of the art modern 75,000 m² facility using the latest manufacturing techniques.

We are based in Zwijndrecht, the Netherlands, from where we supply a portfolio of OEMs and dealer network around the world. UnitedSeats remains committed to innovation, providing seating products and supported by excellent sales and service support.

Our in-house design capability allows us to tailor products for OEM and dealer specification. Our range comprises a selection of air and mechanical suspensions which are both high profile and low profile. Important for forklifts and industrial machines low profile.

These suspensions can be combined with a wide selection of seat uppers and seat pans. Our skill is 'Uniting your seat'.



Our latest range of MG35/MGV55 and MG65 forklift seats importantly meet IT1/IT2 and EN13490 standards. UnitedSeats products, such as our Rancher Std, meet the ISO 6683 (seat belt strength approval) for seat belts used in forklift machines. Compliance with this standard can help ensure the safety of forklift operators by reducing the risk of injuries during operations or a sudden stop.









UnitedSeats has a wide range of safety critical items, such as seat belts and seat switches.

Special armrests and pods are available to carry joystick controls for various machines. These joystick consoles are also available to retrofit our seats. Also a wide variety of spare parts such as dampers and cushions can be supplied.

Above all, our priority is to supply seating solutions to maintain the health and safety of the operator. We also emphasize the need to maintain and repair damaged seats to prevent injuries.

At UnitedSeats we've got your back!

We have seats for the following machinery:

-  Large counterbalance trucks 11 - 16 ton
-  Medium counterbalance trucks 4 - 10 ton
-  Small counterbalance trucks 1 - 4 ton
-  Reach trucks
-  Rough terrain forklifts
-  Baggage tow tractors
-  Side loaders
-  Industrial vehicles

Focus product

MGV65 W

MAXIMUM COMFORT FOR FORKLIFT APPLICATIONS

Our latest range of seats meet EN13490 IT1/IT2 standards for forklift trucks and ISO 7096 (vibration test) for EM1, EM7 & EM8 classes for construction machines. Besides these standards, we focus on providing our seats with a seat belt that meets the ISO 6683 standards (seat belt strength approval). The seats are fully tested and approved for the ISO 5353 (SIP measurement) and ISO 3795 (Flammability test PVC).

Our UnitedSeats MGV65 seats with a SIP point of 210 mm makes them ideal for forklifts & low cabin construction machinery and the 60 mm suspension stroke makes every ride comfortable. The MGV65 is designed with operators in mind with its intuitive weight adjustment lever, NO/NC operator contact switch and 2-point belt, it is a seat that supports the driver in a variety of forklift and construction machines. The seat has integrated controls and a quick weight adjustment. The IP67 - NO/NC seat switch is also standard.

Drainage & ventilation channels

Quick weight adjustment:
from 45 to 170 kg

Suspension
stroke 60 mm

Standard HD PVC,
fabric optional

Integrated 2-point
ELR seat belt

Operator contact
switch NO/NC

Double locking slide rails
at 328 mm centres





MGV35





Seat is also available in fabric trim and in comfort version with seat width 490 mm. Backrest can fold fully forward.

STANDARD FEATURES

-  **Mechanical suspension**
80 mm suspension travel

-  **Weight adjustment**
50 - 155 kg

-  **Slide rail travel**
180 mm

-  **Backrest adjustment**

-  **Fold forward feature**

-  **Operator presence switch NO/NC**

-  **Seat belt**

SEAT MEASUREMENTS

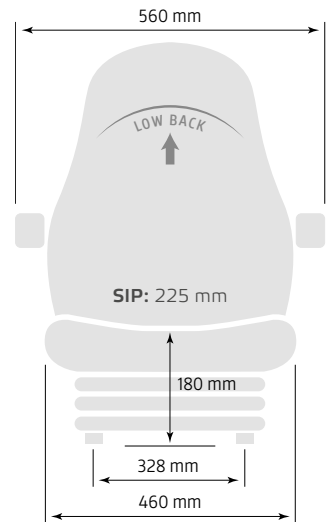

OPTIONS

-  **Heating**
12 V or 24 V

-  **Headrest**

-  **Armrests**

MGV35 LOW SIP



Seat is also available in fabric trim and in comfort version with seat width 490 mm. Backrest can fold fully forward.

STANDARD FEATURES

-  **Mechanical suspension**
65 mm suspension travel

-  **Weight adjustment**
50 - 155 kg

-  **Slide rail travel**
180 mm

-  **Backrest adjustment**

-  **Fold forward feature**

-  **Operator presence switch NO/NC**

-  **Seat belt**

SEAT MEASUREMENTS

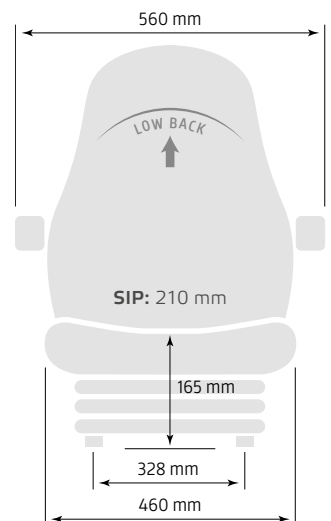

SIP SIP point is 15 mm lower than the standard version

OPTIONS

-  **Heating**
12 V or 24 V

-  **Headrest & armrests**

MGV35 C (COMFORT VERSION)





STANDARD FEATURES

-  **Mechanical suspension**
80 mm suspension travel
-  **Weight adjustment**
50 - 155 kg
-  **Slide rail travel**
180 mm
-  **Backrest adjustment**
-  **Fold forward feature**
-  **Operator presence switch NO/NC**
-  **Seat belt**

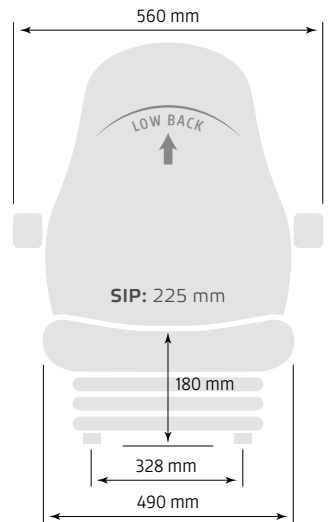
SEAT MEASUREMENTS



OPTIONS

-  **Headrest**
-  **Armrests**



Seat is also available in fabric trim.
Backrest can fold fully forward.

MGV55





STANDARD FEATURES

-  **Mechanical suspension**
80 mm suspension travel
-  **Weight adjustment**
50 - 155 kg
-  **Slide rail travel**
180 mm
-  **Backrest adjustment**
-  **Fold forward feature**
-  **Operator presence switch NO/NC**
-  **Seat belt**

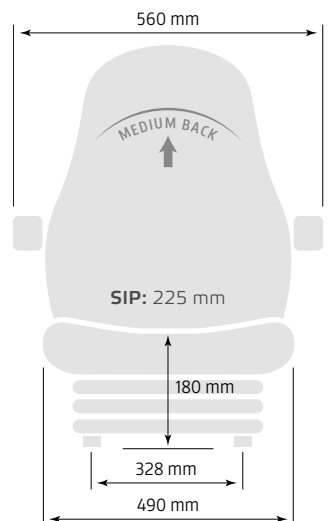
SEAT MEASUREMENTS



OPTIONS

-  **Heating**
12 V or 24 V
-  **Headrest**
-  **Armrests**









Seat is also available in fabric trim.
Backrest can fold fully forward.

MGV55 (SMALL VERSION)





STANDARD FEATURES

-  **Mechanical suspension**
80 mm suspension travel
-  **Weight adjustment**
50 - 155 kg
-  **Slide rail travel**
180 mm
-  **Backrest adjustment**
-  **Fold forward feature**
-  **Operator presence switch NO/NC**
-  **Seat belt**

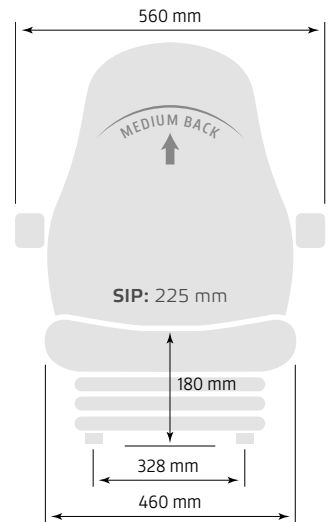
SEAT MEASUREMENTS



OPTIONS

-  **Heating**
12 V or 24 V
-  **Headrest**
-  **Armrests**



Seat is also available in PVC trim.
Backrest can fold fully forward.

MGV25



STANDARD FEATURES

-  **Mechanical suspension**
50 mm suspension travel
-  **Weight adjustment**
50 - 130 kg
-  **Slide rail travel**
150 mm
-  **Backrest adjustment**
-  **Lumbar support**
-  **Fold forward feature**
-  **Operator presence switch NO/NC**

SEAT MEASUREMENTS

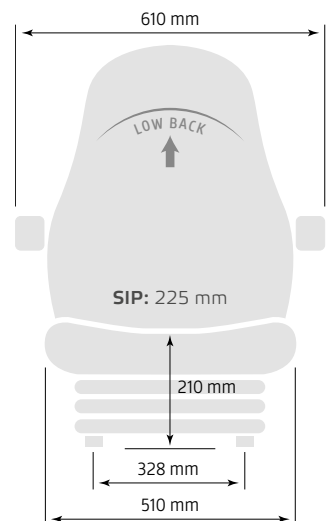

OPTIONS

-  **Headrest**
-  **Armrests**
-  **Seat belt**







Seat is also available in fabric trim.
Backrest can fold fully forward.





MGV25/C5



STANDARD FEATURES

-  **Mechanical suspension**
50 mm suspension travel
-  **Weight adjustment**
50 - 130 kg
-  **Slide rail travel**
150 mm
-  **Backrest adjustment**

OPTIONS

-  **Operator presence switch NO/NC**
-  **Heating**
12 V or 24 V
-  **Backrest extension**
-  **Armrests**
-  **Seat belt**

SEAT MEASUREMENTS

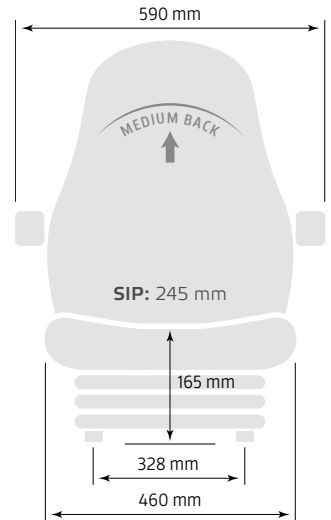





Seat is also available in PVC trim.

CS85/C5



STANDARD FEATURES

-  **Mechanical suspension**
90 mm suspension travel
-  **Weight adjustment**
50 - 125 kg
-  **Height adjustment**
60 mm in 3 stages
-  **Slide rail travel**
150 mm
-  **Backrest adjustment**

OPTIONS

-  **Operator presence switch NO/NC**
-  **Heating**
12 V or 24 V
-  **Backrest extension**
-  **Armrests**
-  **Seat belt**

SEAT MEASUREMENTS

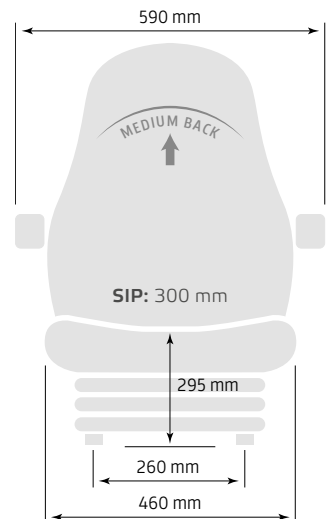

Seat is also available in PVC trim.



LGV35/C5



STANDARD FEATURES

-  **Air suspension**
60 mm suspension travel
-  **Compressor 12 V**
-  **Weight adjustment**
50 - 125 kg
-  **Slide rail travel**
200 mm
-  **Backrest adjustment**

OPTIONS

-  **Operator presence switch NO/NC**
-  **Compressor 24 V**
-  **Heating**
12 V or 24 V
-  **Backrest extension & armrests**
-  **Seat belt**

SEAT MEASUREMENTS

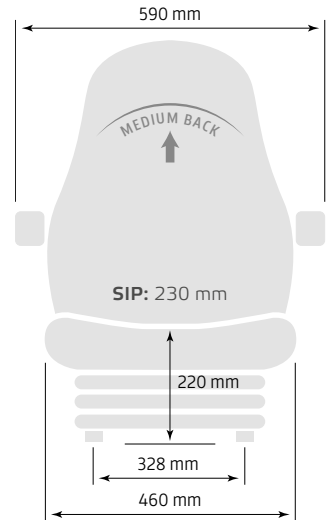

Seat is also available in PVC trim.



LGV64/C2



STANDARD FEATURES



-  **Air suspension**
60 mm suspension travel
-  **Compressor 12 V**
-  **Weight adjustment**
45 - 125 kg
-  **Slide rail travel**
180 mm
-  **Backrest adjustment**
-  **Operator presence switch NO/NC**
-  **Armrests**

OPTIONS

-  **Compressor 24 V**
-  **Heating**
12 V or 24 V
-  **Lumbar support**

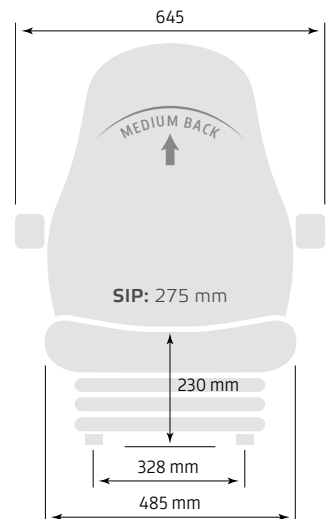
SEAT MEASUREMENTS



-  **Backrest extension**
-  **Seat belt**







Seat is also available in fabric trim.





MGV25/C1



STANDARD FEATURES

-  **Mechanical suspension**
50 mm suspension travel
-  **Weight adjustment**
50 - 130 kg
-  **Slide rail travel**
150 mm
-  **Backrest adjustment**
-  **Lumbar support**

OPTIONS

-  **Operator presence switch NO/NC**
-  **Heating**
12 V or 24 V
-  **Backrest extension**
-  **Armrests**
-  **Seat belt**

SEAT MEASUREMENTS

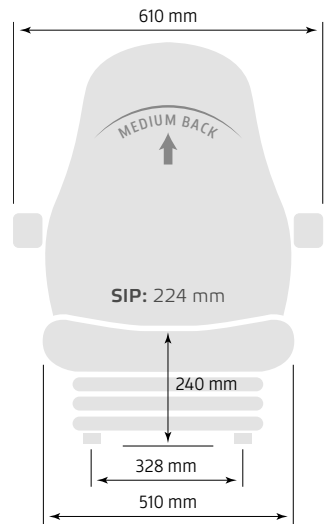







Seat is also available in PVC trim.





CS85/C1



STANDARD FEATURES

-  **Mechanical suspension**
90 mm suspension travel
-  **Weight adjustment**
50 - 125 kg
-  **Height adjustment**
60 mm in 3 stages
-  **Slide rail travel**
150 mm
-  **Backrest adjustment**
-  **Lumbar support**

OPTIONS

-  **Operator presence switch NO/NC**
-  **Heating**
12 V or 24 V
-  **Backrest extension & armrests**
-  **Seat belt**

SEAT MEASUREMENTS

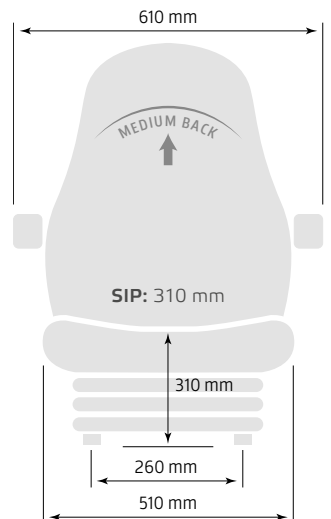

Seat is also available in fabric trim.





LGV35/C7

STANDARD FEATURES

-  **Air suspension**
60 mm suspension travel

-  **Compressor 12 V**

-  **Weight adjustment**
50 - 125 kg

-  **Slide rail travel**
200 mm

-  **Backrest adjustment**

-  **Seat belt 3P**

OPTIONS

-  **Operator presence switch NO/NC**

-  **Compressor 24 V**

-  **Lumbar support**

SEAT MEASUREMENTS

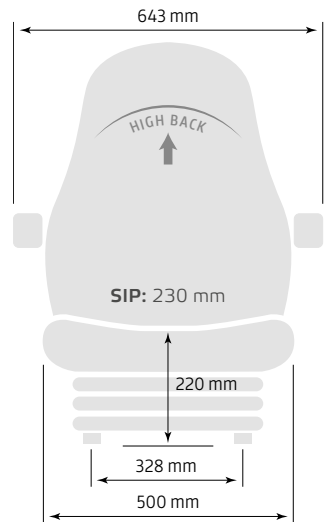

-  **Heating**
12 V or 24 V

-  **Headrest & armrests**



Seat is also available in fabric trim.



PVC version



MG20

STANDARD FEATURES

-  **Mechanical suspension**
40 mm suspension travel

-  **Weight adjustment**
50 - 130 kg

-  **Slide rail travel**
150 mm

-  **Backrest adjustment**

-  **Operator presence switch NO/NC**

OPTIONS

-  **Armrests**

-  **Seat belt**

SEAT MEASUREMENTS

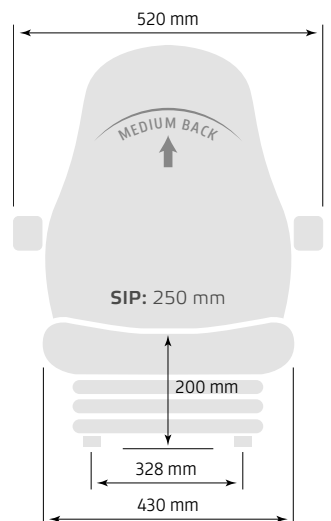

Seat is also available in PVC trim.

RANCHER STD



STANDARD FEATURES

-  **Air suspension**
120 mm suspension travel

-  **Compressor 12 V**

-  **Weight adjustment**
50 - 135 kg

-  **Height adjustment**
80 mm stepless

-  **Slide rail travel**
210 mm

-  **Fore/aft isolator**

-  **Backrest adjustment**

-  **Lumbar support**

-  **Adjustable damper**

-  **Turntable**
20°/20° swivel

-  **Backrest extension & armrests**

SEAT MEASUREMENTS

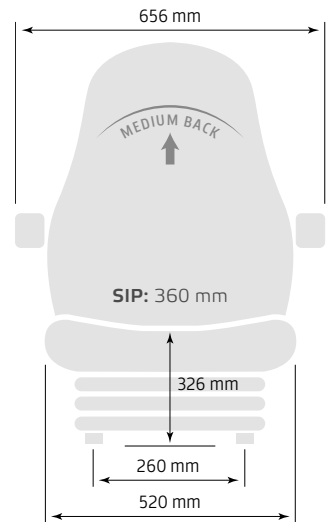

OPTIONS

-  **Operator presence switch NO/NC**

-  **Compressor 24 V**

-  **Seat belt**





Seat is also available in PVC trim.

RANCHER ARTISAN





STANDARD FEATURES

-  **Air suspension**
120 mm suspension travel

-  **Compressor 12 V**

-  **Weight adjustment**
50 - 135 kg

-  **Height adjustment**
80 mm stepless

-  **Slide rail travel**
210 mm

-  **Fore/aft isolator**

-  **Backrest adjustment**

-  **Lumbar support**

-  **Adjustable damper**

-  **Backrest extension**

-  **Armrests**

SEAT MEASUREMENTS

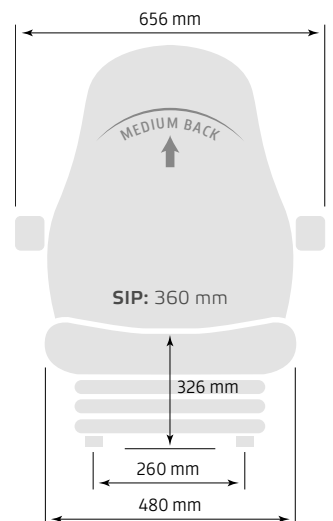

OPTIONS

-  **Operator presence switch NO/NC**

-  **Compressor 24 V**

-  **Seat belt**





Fabric version



Seat is in heavy duty PVC. Also available in fabric trim.

US20

STANDARD FEATURES

-  **Mechanical suspension**
40 mm suspension travel

-  **Weight adjustment**
50 - 125 kg

-  **Slide rail travel**
150 mm

-  **Slide rail adjustment**
150 - 328 mm in width

-  **Backrest adjustment**

-  **Operator presence switch NO/NC**

SEAT MEASUREMENTS

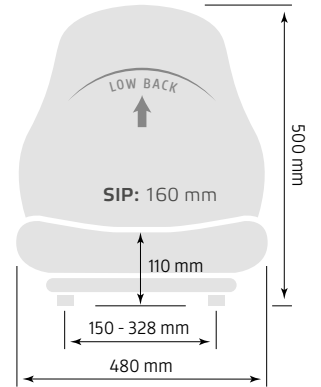

OPTIONS

-  **Heating (seat cushion only)**
24 V

-  **Armrests**

-  **Seat belt**

GS12

STANDARD FEATURES

-  **Mechanical suspension**
40 mm suspension travel

-  **Weight adjustment**
50 - 125 kg

-  **Slide rail travel**
150 mm

-  **Backrest adjustment**

-  **Operator presence switch NO/NC**

SEAT MEASUREMENTS

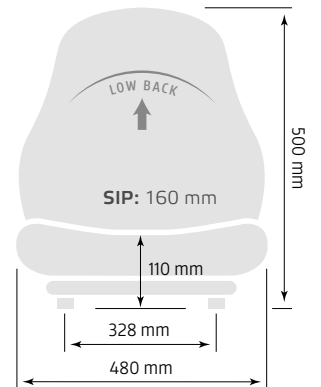

OPTIONS

-  **Heating**
24 V

-  **Armrests**

-  **Seat belt**



Seat is in heavy duty PVC. Also available in fabric trim.



Mi800

STANDARD FEATURES

- Seat pan PVC with drainage
- Water- and weather proof
- One piece foam
- Plastic shell

OPTIONS

- Operator presence switch NO/NC
- Seat belt
- Slide rails
- Armrests
- Suspension
- Yellow PVC

SEAT MEASUREMENTS

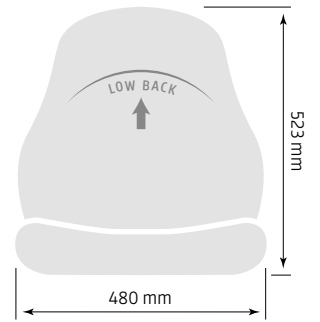

Mi600

STANDARD FEATURES

- Seat pan PVC with drainage
- Water- and weather proof
- One piece foam
- Plastic shell
- Multi hole mounting pattern

OPTIONS

- Operator presence switch NO/NC
- Seat belt
- Slide rails
- Suspension
- Yellow PVC
- Grey PVC

SEAT MEASUREMENTS

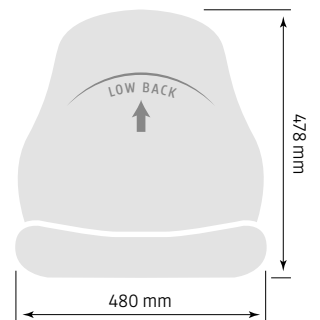

Also available in low back version Mi150.

Mi560

STANDARD FEATURES

Seat pan PVC with drainage

Water- and weather proof

One piece foam

Steel shell

Multi hole mounting pattern

OPTIONS

Seat belt

Slide rails

Turntable

Suspension

SEAT MEASUREMENTS

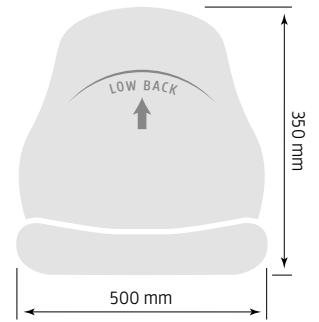

Yellow

Mi1000

STANDARD FEATURES

Seat pan PVC

Water- and weather proof

One piece foam

Steel shell

Multi hole mounting pattern

OPTIONS

Operator presence switch NO/NC

Seat belt

Slide rails

Suspension

Yellow PVC

SEAT MEASUREMENTS

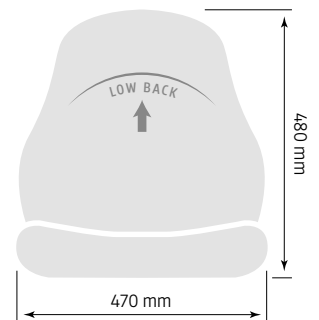

SEAT OPTIONS

Different types of armrests



Multi adjustable armrests



Air & mechanical suspensions



Slide rails



Various seat belts



Turntables



SEAT OPTIONS

Operator presence switch



Crouzet switch - IP67, NO/NC



Fore/aft isolator



Heating



Joystick console



Headrests and custom logo



SPECIALTY PRODUCTS & BUILDS

Various builds and options for seats.
Further options available upon request.



LGV90/C7 Pro with pods



MGV35 with joystick armrest



C5 upper with logo

SEAT & BACK CUSHIONS

Fabric and PVC replacement cushions.
Further options available upon request.



SPECIALTY PRODUCTS & BUILDS

Custom build 2, 3 & 4-point seat belt.
Further options available upon request.



2-point Hi-Viz seat belt



3-point Hi-Viz seat belt



4-point red belt harness

2-, 3- AND 4-POINT SEAT BELTS

ALR/ELR type available.
Further options available upon request.

ON.151107



ON.150755



ON.151109



ON.151108



ON.150756S



ON.150855



QUALITY **SEATING** MANUFACTURER

Custom **made in** Holland



At UnitedSeats we are dedicated to providing a quality service from the initial quotation to final product delivery. Our commitment to service, knowledge and product availability has made us the preferred source for your seating needs.

WWW.UNITEDSEATS.COM

